

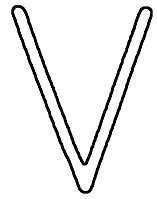

va ve vi vo vu

Va Ve Vi Vo Vu



lluvia

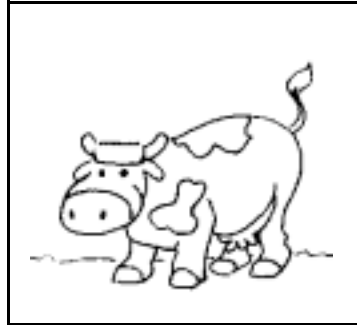

vaca



vela

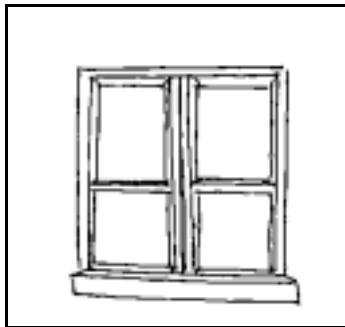

ventana

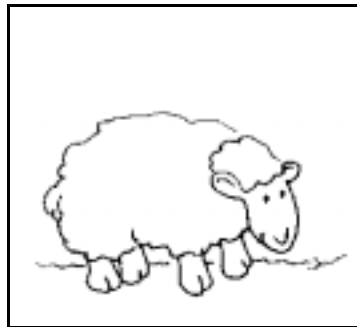

oveja



avión

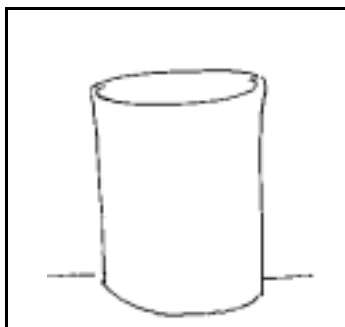

vaso

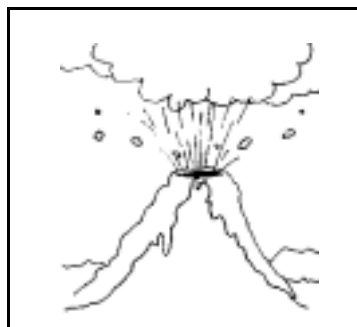

volcán

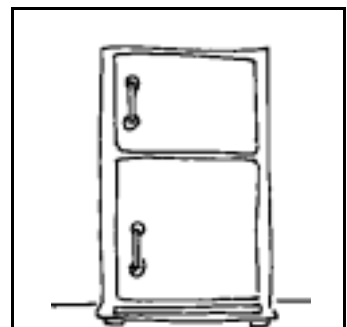

nevera

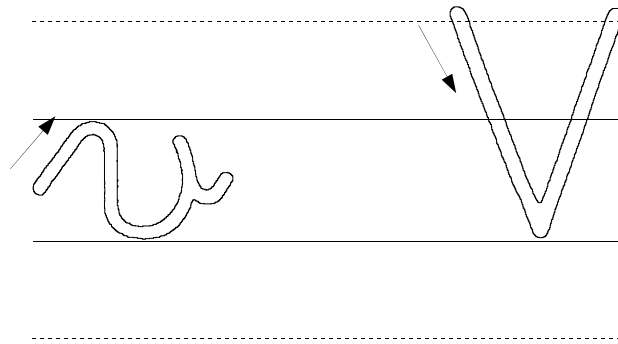

va ve vi ve vu

Va Ve Vi Ve Vu

oveja avión vaca volcán arispa
nevera vaso ventana vela ura
televisión verde Vicente valor

La oveja come hierba

Llueve en Sevilla

La vaca sale del establo

La vela la apaga el viento

Cierra bien la ventana

El avión sube a las nubes

Llena el vaso de leche

Este volcán me da miedo



Va Ve Vi Vo Vu

ra ve vi vo vu

La botella de vino

La lluvia moja el paraguas

Vaca y oveja comen hierba

Pongo en la nevera la uva

Veo la televisión en el salón

El viento mueve la vela del yate

Llevo al perro de paseo

Uva y queso saben a beso



La oveja come hierba.

¿Qué come la oveja?

Veo en la televisión una película.

¿Qué veo en la televisión?

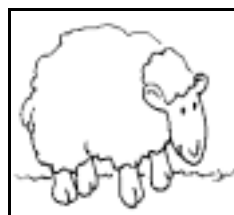
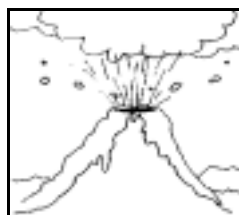
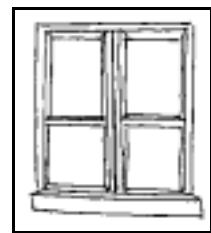
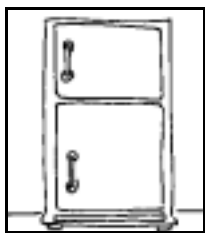
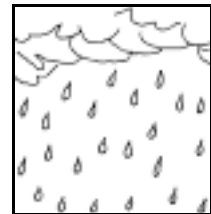
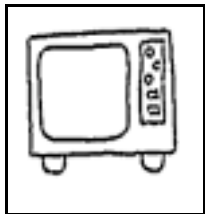

la uva
 el pavo
 la lluvia
 el televisor
 la nevera
 la vela
 la ventana
 el avión
 el volcán
 la oveja

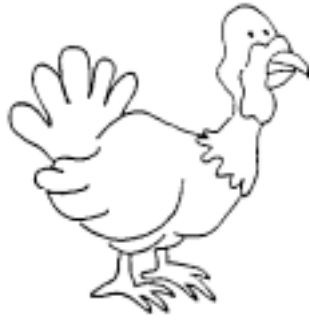

para



uva



lluvia



lavadora



avión

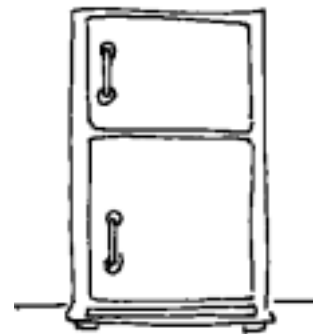

nevera



vaca



oveja



avispa

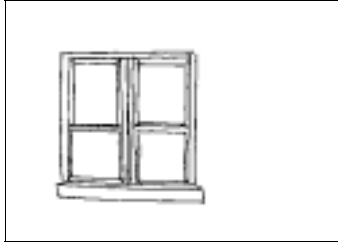

Pinto la ventana de verde

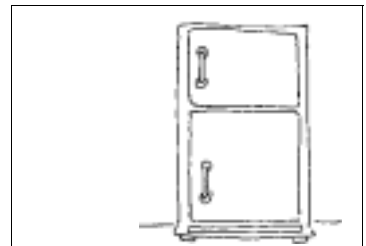

Meto un vaso en la nevera

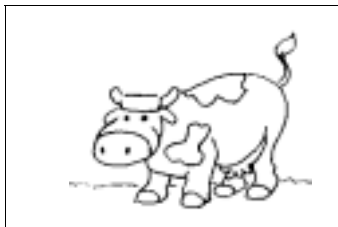

A la vaca le gusta la hierba

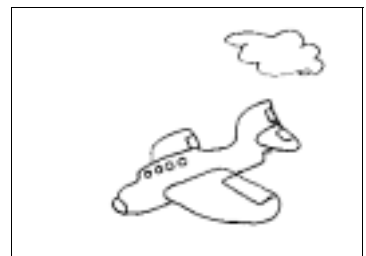

El avión sube hasta la nube



uno

muchos

el televisor	los televisores
el automóvil	los automóviles
el camión	los camion_____
el violín	los v_____
la Navidad	las
el avión	
el lápiz	
el tapón	
el volcán	

~~una~~ balcón vaca hierba nieve abeto
cubo lavadora sábado nueve

v
una

b



 <p>Leo...</p>	<p>Eva y Vicente</p>	
		
<p>Eva tiene seis años</p>	<p>Es vecina de Vicente</p>	<p>Los dos juegan al parchis en casa de Vicente</p>
		
<p>¿Qué hay en la ventana? ¡Qué susto!</p>	<p>Eva es muy valiente</p>	<p>No te asustes, Vicente, es Lulú.</p>

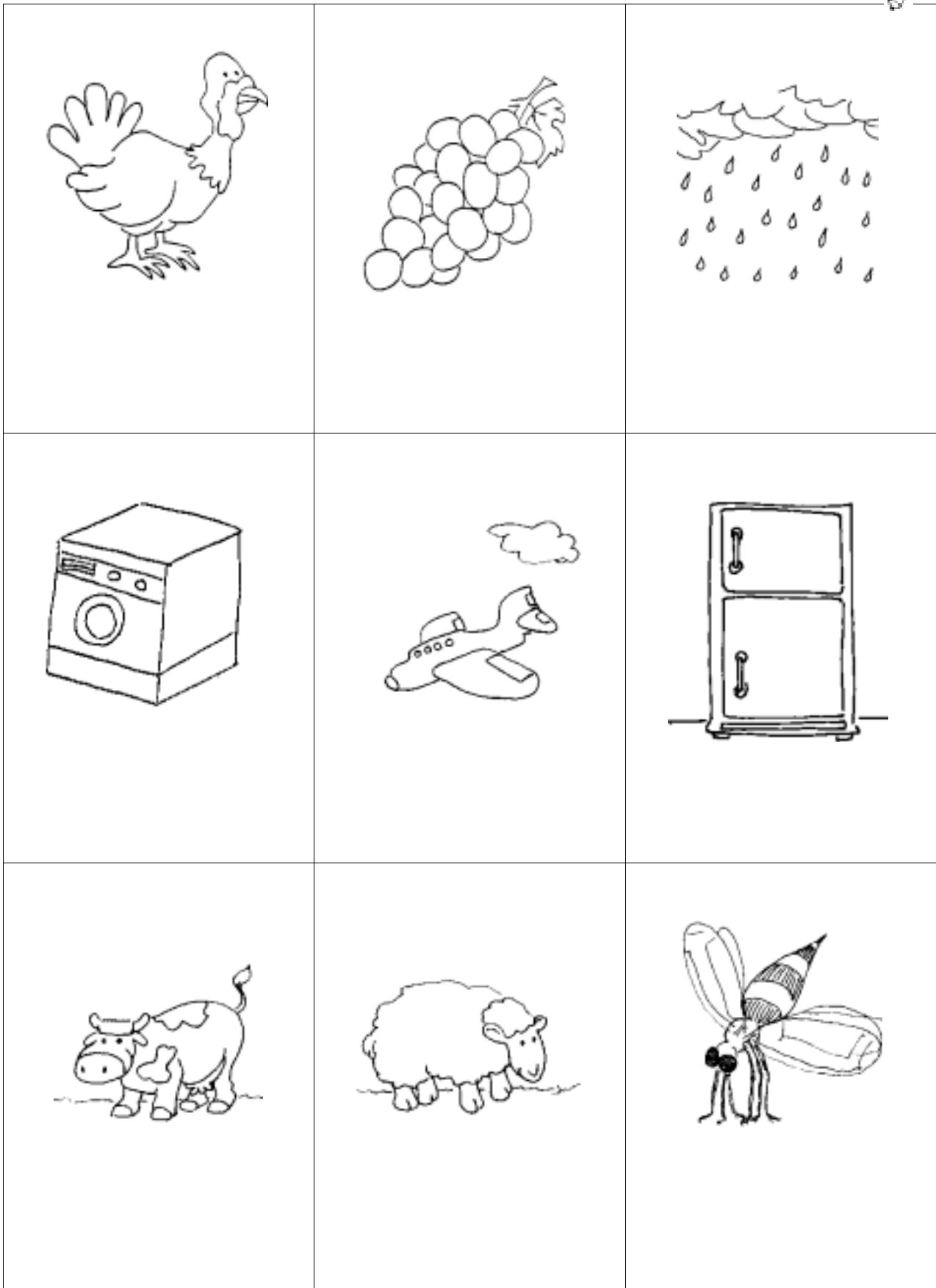



Eva tiene un



Como



,



y



Bebó un



de



Apago la



con un



La



y

la



comen hierba



Tema 28	第二十八课	Unit 28
Eva y Vicente.	埃娃和比森特。	Eva and Vicente.
Eva tiene siete años.	埃娃有七岁了。	Eva is seven years old.
Es vecina de Vicente.	是比森特的邻居。	She is a neighbor of Vicente.
Los dos juegan al parchís en casa de Vicente.	他们两个在比森特的家玩帕	They both are playing parcheesi at Vicente's house.
¿Qué hay en la ventana? ¡Qué susto!	窗上有什么？吓我一跳！	What is at the window? What a fright!
Eva es muy valiente.	埃娃很勇敢。	Eva is very brave.
No te asustes, Vicente, es Lulú.	别害怕，比森特，是露露。	Don't be frightened, Vicente, it is Lulú.
		
La botella de vino.	葡萄酒的瓶子。	The bottle of wine.
La lluvia moja el paraguas.	雨把雨伞弄湿了。	The rain makes the umbrella wet.
Vaca y oveja comen hierba.	牛和绵羊吃草。	The cow and the sheep eat grass.
Pongo en la nevera la uva.	我把葡萄放在冰箱里。	I am putting the grape in the fridge.
Veo la televisión en el salón.	我在客厅里看电视。	I am watching TV in the living room.
El viento mueve la vela del yate.	风吹动游艇的帆。	The wind is moving the sail of the yacht.
Llevo al pavo de paseo.	我带着火鸡散步。	I am taking the turkey for a walk.
Uva y queso saben a beso.	葡萄和奶酪非常好吃	Grapes and cheese taste like a kiss.