

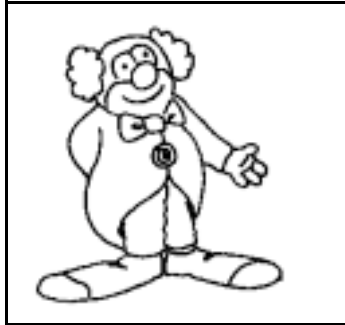

ya ye yi yo yu

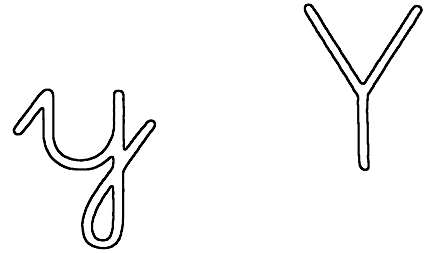

payaso

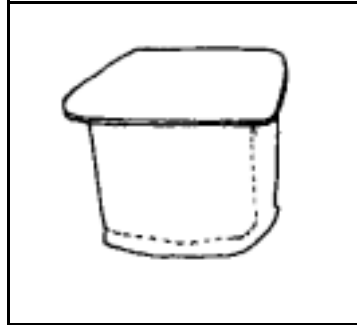

yogur

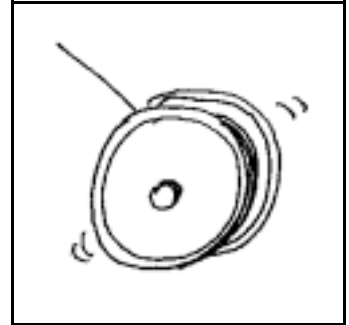

yoyo

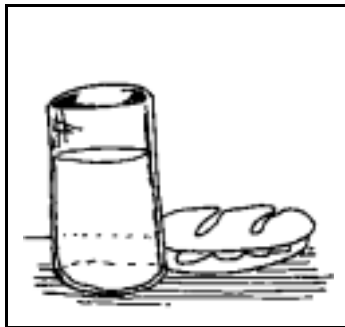

desayuno



rayo

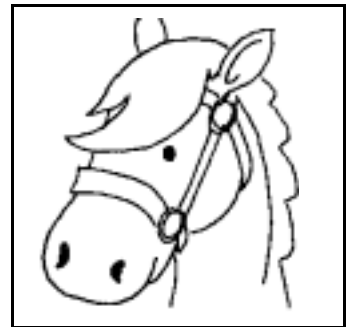

yegua



mayúsculas



mayonesa



joya

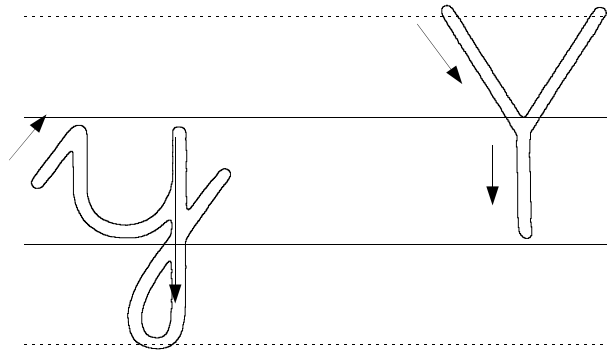

ya ye yi yo yu
Ya Ye Yi Yo Yu

yo Yolanda yate yaya yogur
yoyo payaso mayúscula joya
mayonesa yegua playa rayo
papagayo yema tuya hoyo

Yolanda se pone la joya.
Pongo la M mayúscula.
De la nube sale el rayo.
Como pan con mayonesa.
La yegua se baña en el río.
El payaso hace reír.
Tengo un yate de juguete.



Ya Ye Yi Yo Yu

ya ye yi yo yu

La yegua se mete en el lago

Yolanda juega en la playa

Alí come yogur con piñones

Papá regala un yoyo a su hijo

Desayuno leche con chocolate

El payaso entra en el circo

La familia de Hua sube al yate

Mamá compra una joya



Rafa tiene un yoyo.

¿Qué tiene Rafa?

Desayuno leche con chocolate.

¿Qué desayuno?

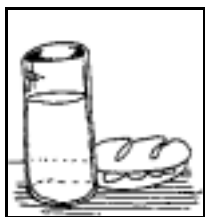
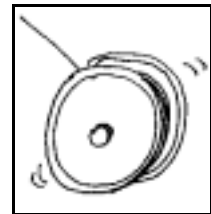
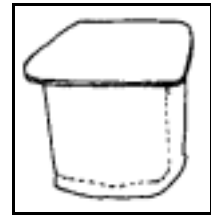

el yate
 las mayúsculas
 el yogur
 el yoyo
 el desayuno
 la yegua
 la joya
 el payaso
 el rayo
 la mayonesa



yogur



yate



yegua

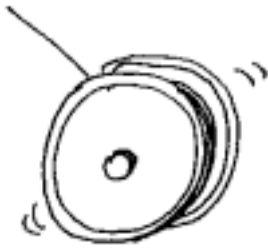

yoyo



desayuno



mayonesa



rayo



joya



payaso

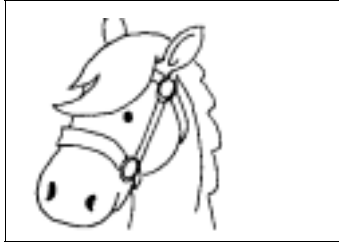

La yegua se mete en el lago



Ali come yogur con piñones

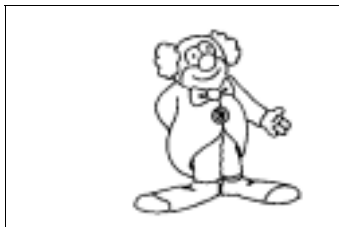

El payaso juega con el yoyo

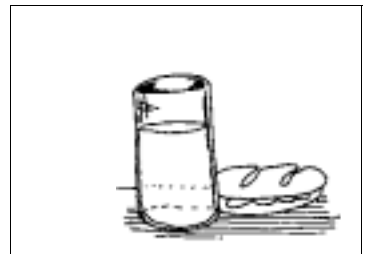

Desayuno chocolate con leche



YA Pongo en mayúsculas

hoy	HOY
yoyo	YOYO
yate	Y
yogur	
rayo	
mayonesa	
camión	
peces	
tijeras	

~~yate~~ mochila coche yoyo payaso mucho
poncho mayonesa chimenea rayo

ya ye yi yo yu
yate

cha che chi cho chu



 <p>Leo...</p>	<p>El payaso Agustín</p>	
		
<p>Agustín es un payaso</p>	<p>Actúa en el circo</p>	<p>Se monta en la yegua</p>
		
<p>Hace piruetas y da saltos</p>	<p>Juega con un yoyo</p>	<p>Todos se ríen mucho.</p>





Rafa juega con su



Como



con



La



juega con el agua

Me asusta el



Toñi regala una



a su mamá



Toñi es una niña rubia.
Toñi tiene ocho años.
Su abuela le regala una muñeca.
Mañana irá a la montaña de paseo.



✎ COMPLETA

Toñi es una _____ rubia.

Su abuela le regala una _____.

Toñi tiene ocho _____.

Mañana irá de _____ a la _____.

✎ CONTESTA

¿Quién es Toñi?

¿Qué le regaló su abuela?

¿Cuántos años tiene Toñi?

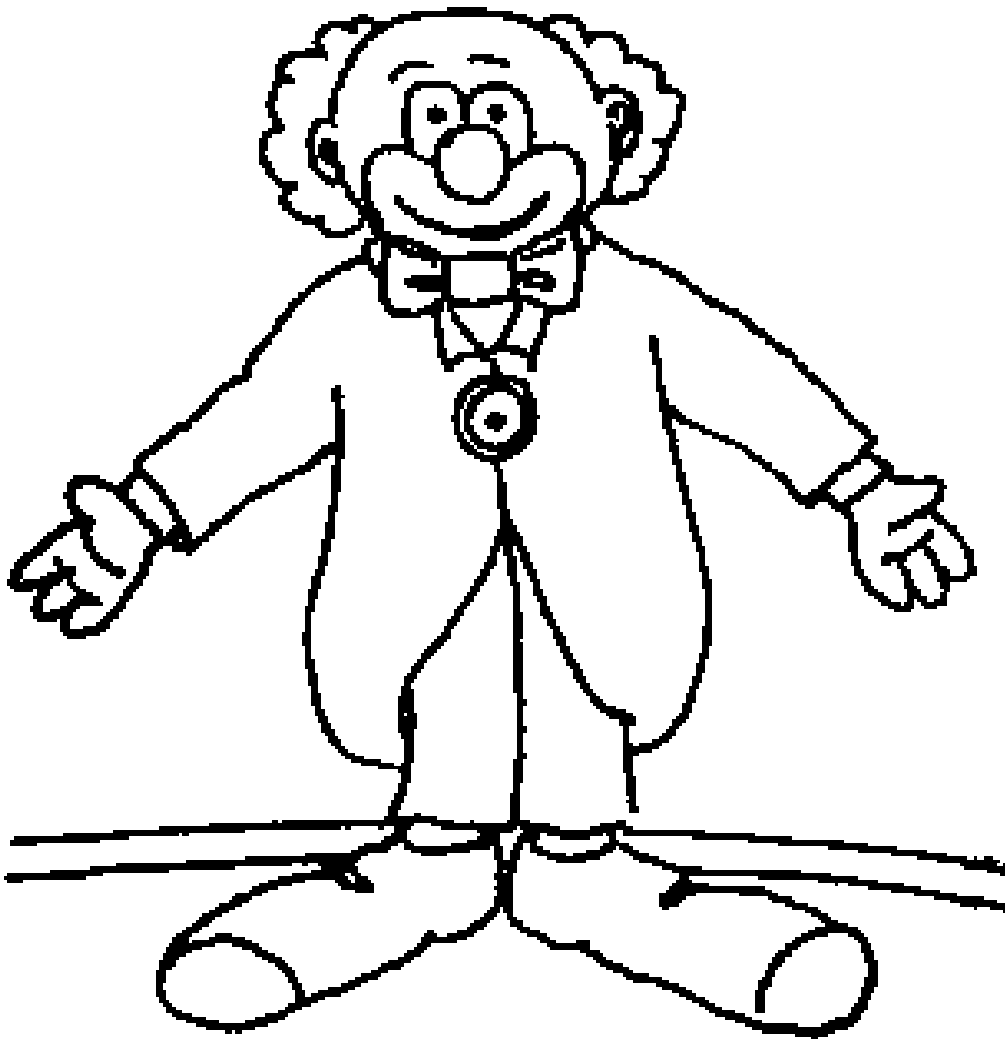

CONTESTA

¿Quién es? _____

Coloreo la chaqueta de color rojo.

Coloreo los pantalones de color amarillo.



Tema 24	第二十四课	Unit 24
El payaso Agustín.	小丑阿古斯丁。	Agustín the clown.
Agustín es un payaso.	阿古斯丁是小丑。	Agustín is a clown.
Actúa en el circo.	在马戏团表演。	He acts in the circus.
Se monta en la yegua.	他骑着一匹母马。	He rides the mare.
Hace piruetas y da saltos.	旋转和跳跃。	He performs pesades and jumps.
Juega con el yoyo.	玩约约(一种小孩玩具)。	He plays with the yo-yo.
Todos se ríen mucho.	大家都高兴地笑。	Everybody laughs a lot.



La yegua se mete en el lago.	母马走进湖里。	The mare goes into the lake.
Yolanda juega en l playa.	幽兰达在海滩玩。	Yolanda is playing at the beach.
Alí como yogur con piñones.	阿里吃酸奶和松子。	Alí is eating some yogurt with pine nuts.
Papá regala un yoyo a su hijo.	爸爸送给他孩子一个约约。	Dad is giving a yo-yo to his son as a present.
Desayuno leche con chocolate.	我早饭吃巧克力牛奶。	I have milk with chocolate for breakfast.
El payaso entra en el circo.	小丑进马戏团。	The clown is coming into the circus.
La familia de Hua sube al yate.	华的家人上了游艇。	Hua's family is going up to the yacht.
Toñi compra una joya a su mamá.	托尼买一个首饰给她妈妈。	Toñi is buying a piece of jewelry for her mum.